

AJUSTADORES PARA BALATA

HO-162 **BALATAS**
881 A 269
N.E. 10

VW SEDAN (73-94)
(2 POR RUEDA) RYL

HO-163

VW COMBI (74-98)
(2 POR RUEDA) RYL

HO-162AR **BALATAS**
1354 497
N.E. 1

VW CARIBE (R)
(77-85)

HO-162AL

VW CARIBE (L)
(77-85)

HO-194R **BALATAS**
13X0 FT003
427
N.E. 1

CHEVROLET CHEVY
MONZA (R) (94-00)

HO-194L

CHEVROLET CHEVY
MONZA (L) (94-00)

HO-195R **BALATAS**
2164 553
N.E. 1

CHEVROLET CAVALIER
(R) (90-95)

HO-195L

CHEVROLET
CAVALIER
(L) (90-95)

HO-196R **BALATAS**
2165 T-552
N.E. 1

OLDSMOBILE CUTLASS
(R) (87-91)

HO-196L

OLDSMOBILE
CUTLASS
(R) (87-91)

HO-197 N.E. 1

UNIVERSAL
CORTO (R)

HO-198

UNIVERSAL
CORTO (L)

HO-199 N.E. 1

UNIVERSAL
LARGO (R)

HO-200

UNIVERSAL
LARGO (L)

HO-201 **BALATAS**
2137 314
2171 583
N.E. 1

FORD F-350
(R) (68-98)

HO-202

FORD F-350
(L) (68-98)

HO-203 **BALATAS**
2137 314
2171 583
N.E. 1

DODGE D-300 D-350
(R) (73-90)

HO-204

DODGE D-300
D-350
(L) (73-90)

HO-205 **BALATAS**
2157AT S656
2042BT S655
N.E. 1

CHEVROLET
C-30 (R)

HO-206

CHEVROLET
C-30 (L)

HO-205A **BALATAS**
2157AT S656
2042BT S655
N.E. 1

CHEVROLET MICRO
(R) (90-96)

HO-206A

CHEVROLET MICRO
(L) (90-96)

01800-1HUANTE

*HO-R= REPUESTO PARA CALIPER
*C.E.= CÓDIGO EQUIVALENTE *N.E. = NÚMERO DE EMPAQUE

HO-236

DODGE CARAVAN
D-100 MONACO FORD
RANGER (R) (84-02)

BALATAS
2168 538
2089AT 705

N.E. 1

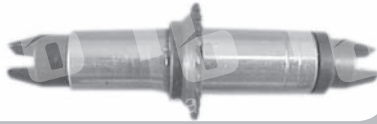

HO-237

DODGE CARAVAN
D-100 MONACO FORD
RANGER (L) (84-02)

HO-246

FORD TOPAZ
(84-94) (R)

BALATAS
1350-501
N.E. 1



HO-247

FORD TOPAZ
(84-94) (L)

HO-248

CHRYSLER "K"
(83-93) (R)

BALATAS
415-520
N.E. 1

HO-249

CHRYSLER "K"
(83-93) (L)



HO-248A

CHRYSLER SHADOW,
SPIRIT (94-95) (R)

BALATAS
1456 S657
N.E. 1

HO-249A

CHRYSLER SHADOW,
SPIRIT (94-95) (L)



HO-250AR

DATSUN PICK-UP (R)
(A-720) (A-620 U.S.A.)
CON SEGUROS
(78-87)

BALATAS
8123 406
N.E. 1

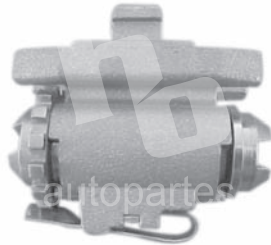

HO-250

JUEGO DE SEGUROS
DE AJUSTADOR PARA
DATSUN PICK-UP
(78-87)

N.E. 10



HO-250AL

DATSUN PICK-UP (L)
(A-720) (A-620 U.S.A.)
CON SEGUROS
(78-87)

HO-251



BALATAS
1354 497
N.E. 10

SEGURO DE AJUSTADOR PARA
VW CARIBE (77-85)

HO-254

NISSAN TSURU I
(84-87) Y II (88-91) (R)

BALATAS
1373 532
N.E. 1

HO-255

NISSAN TSURU I
(84-87) Y II (88-91) (L)



HO-254AR

NISSAN TSURU
III (94-07) (R)

BALATAS
1438-S638
N.E. 1

HO-255AL

NISSAN TSURU
III (94-07) (L)



HO-276

G.M.C. SIERRA (94-98), CHEVROLET
SILVERADO (94-98), PICK-UP (88-94), BLAZER,
TAHOE, YUKON, SUBURBAN (88-94) (R)

BALATAS
1404A S675
1404 593

N.E. 1

HO-277

G.M.C. SIERRA (94-98), CHEVROLET
SILVERADO (94-98), PICK-UP (88-94), BLAZER,
TAHOE, YUKON, SUBURBAN (88-94) (L)



AJUSTADORES PARA BALATA

HO-276A GEO TRACKER (L) (99-01) **BALATAS 1506 738**
N.E. 1

HO-277A GEO TRACKER (R) (99-01)

HO-276B GEO TRACKER (R) (03-04) **BALATAS 1492 S711**
N.E. 1

HO-277B GEO TRACKER (L) (03-04)

HO-278 NISSAN PICK-UP D-21 (93-03) (R) **BALATAS 1399-574**
N.E. 1

HO-279 NISSAN PICK-UP D-21 (93-03) (L)

HO-278A TOYOTA LONG BED XTRA CAB (92-93) PICK-UP (84-94) (R) **BALATAS 1358 505**
N.E. 1

HO-279A TOYOTA LONG BED XTRA CAB (92-93) PICK-UP (84-94) (L)

HO-317 FORD THUNDERBIRD (89-92) (R) **BALATAS 1396 S618**
1452 S665
N.E. 1

HO-318 FORD THUNDERBIRD (89-92) (L)

HO-329 **BALATAS 405**
N.E. 1

JGO. DE LEVA AJUSTADOR DE BALATA DELANTERA PARA DATSUN PICK-UP (78-87) (RYL)

HO-333 MERCURY COUGAR, (89-92) (R) **BALATAS 1396 S618, S655**
N.E. 1

HO-334 MERCURY COUGAR (89-92) (L)

HO-346 BUICK CENTURY OLDSMOBILE CUTLASS (91-96) (R) **BALATAS 1487 S636**
1496 S720
N.E. 1

HO-347 BUICK CENTURY OLDSMOBILE CUTLASS (91-96) (L)

HO-400L TOYOTA LANDCRUISER (75-90) 4 RUNNER (85-00) (L) **BALATAS 1397-589**
N.E. 1

HO-400R TOYOTA LANDCRUISER (75-90) 4 RUNNER (85-00) (R)

HO-402L AJUSTADOR BALATA TOYOTA CRESSIDA (74-80) (L) **BALATAS 8089 407**
N.E. 1

HO-402R AJUSTADOR BALATA TOYOTA CRESSIDA (74-80) (R)

01800-1HUANTE

HO-403L

TOYOTA COROLLA
(L) (83-88)

BALATAS
8105 551
N.E. 1

HO-403R

TOYOTA COROLLA
(R) (83-88)



HO-406L

**CHEVROLET CHEVY-
LUV (92-00) ISUZU
PICK-UP (L) (88-95)**

BALATAS
1360 S619
N.E. 1

HO-406R

**CHEVROLET CHEVY-LUV (92-00),
ISUZU PICK-UP (R) (88-95)**



HO-412L

HYUNDAI ATOS
(L) (97-06)

BALATAS
1379 S707
N.E. 1

HO-412R

HYUNDAI ATOS
(R) (97-06)



HO-414L

HONDA ACCORD
(L) 4 Y 6 cil. (90-00)

BALATAS
1429 627
N.E. 1

HO-414R

HONDA ACCORD
(R) 4 Y 6 cil. (90-00)



HO-416L

HONDA CIVIC
(L) (92-00)

BALATAS
1364 576
1379 S639

HO-416R

HONDA CIVIC
(L) (92-00)

N.E. 1



HO-418R

BALATAS
1344 565
N.E. 1

HO-418L



**MAZDA PICK-UP (86-93), MAZDA 4X2 (89-96), MAZDA B
1800, B 2000, B 2200, B 2300, B 2600**

HO-429L

NISSAN PLATINA
(L) (02-05)

BALATAS
952
1X20 FT006

HO-429R

NISSAN PLATINA
(R) (02-05)

N.E. 1



HO-431L

BALATAS
1485ATT S714
N.E. 1

HO-431R



**CHRYSLER GRAND VOYAGER, TOWN & COUNTRY
(97-01), VOYAGER (01-02)**

HO-434L

**MITSUBISHI MIRAGE (83-88), MITSUBISHI
LANCER (89-91), CHRYSLER COLT (89-91) (L).**

BALATAS
6670-6694
N.E. 1

HO-434R

**MITSUBISHI MIRAGE (83-88),
MITSUBISHI LANCER (89-91),
CHRYSLER COLT (89-91) (R).**



HO-436L

**CHEVROLET CHEVY
PICK-UP (L) (99-03)**

BALATAS
8428 951
2X64 FT001

HO-436R

**CHEVROLET CHEVY
PICK-UP (R) (99-03)**

N.E. 1



AJUSTADORES PARA BALATA

HO-445R DODGE NEON, STRATUS (02-06) (R) **BALATAS 643** N.E. 10

HO-445L DODGE NEON, STRATUS (02-06) (L)

HO-454R AJUSTADOR PARA BALATA NISSAN TSUBAME (92-03) (R) **BALATAS 1381 575 1381 607** N.E. 1

HO-454L AJUSTADOR PARA BALATA NISSAN TSUBAME (92-03) (L)

HO-463A PONTIAC MATIZ (05-06) (R) **BALATAS 12X3 FT-008** N.E. 1

HO-463B PONTIAC MATIZ (05-06) (L) **BALATAS 12X3 FT-008** N.E. 1

HO-J235H **N.E. 1**

JUEGO DE AJUSTADORES PARA FRENO CAMIONES F-600, (71-85) (R) Y (L) (2 PIEZAS)

HO-019H **N.E. 1**

ESPÁTULA PARA AJUSTE DE FRENOS

NUEVO **HO-492L** **BALATAS 1513 S747** N.E. 1

AJUSTADOR PARA FRENO DE TAMBOR FORD FOCUS (L) (01-05)

HO-492R **BALATAS 1513 S747** N.E. 1

AJUSTADOR PARA FRENO DE TAMBOR FORD FOCUS (R) (01-05)

NUEVO

NUEVO **HO-493L** **BALATAS 1X81 FT024** N.E. 1

AJUSTADOR PARA FRENO DE TAMBOR FORD FIESTA, IKON (L)

HO-493R **BALATAS 1X81 FT024** N.E. 1

AJUSTADOR PARA FRENO DE TAMBOR FORD FIESTA, IKON (R)

NUEVO

01800-1HUANTE

TAPONES GRASERA PARA RUEDA

HO-259 Ø.40.30mm N.E. 1

DATSUN-VW CARIBE (77-87)

HO-259T Ø.ext. 55.60mm N.E. 1

PEUGEOT

HO-260 Ø.46.05mm N.E. 1

NISSAN TSURU I (84-87)

HO-260A Ø.52.90mm
N.E. 1

NISSAN TSURU II (88-92)

HO-260B Ø.52.17mm
N.E. 1

NISSAN TSURU III (93-00)

HO-261 Ø.50.00mm
N.E. 1

**NISSAN DATSUN PICK-UP
ICHI-VAN (87-97)**

HO-261A Ø.40.00mm
N.E. 1

DATSUN MODELO VIEJO (72-86)

HO-262 Ø.46.00mm
N.E. 1

**CHRYSLER CÓDIGO "K" (84-88) SPIRIT
(84-90) DODGE D-100 Y D-150 (84-02).**

HO-263 Ø.62.20mm
N.E. 1

DODGE MICRO D-300 D-350 (73-94)

HO-264 Ø.45.90mm
N.E. 1

FORD AUTO (81-94)

HO-264T Ø.ext. 66.20mm
N.E. 1

CHRYSLER INTREPID (95-01)

HO-265 Ø.50.00mm
N.E. 1

**FORD PICK-UP (76-96)
TOYOTA HILUX (79-97)**

HO-266 Ø.63.60mm
N.E. 1

FORD MICRO F-350 (70-96).

HO-266T Ø.ext. 64.00 mm
N.E. 1

MERCURY GRAND MARQUIS (95-01)

HO-267 Ø.63.10mm
N.E. 1

CHEVROLET MICROBUS (71-90)

HO-267A Ø.53.03mm
N.E. 1

CHEVROLET AUTO Y PICK-UP (80-96)

HO-268 Ø.47.92mm
N.E. 1

VW 1500 (73-82)

HO-269 Ø.48.17mm
N.E. 1

VW 1600 (PERFORADO) (83-94)

TAPONES GRASERA PARA RUEDA

<p>HO-269A \varnothing48.17mm N.E. 1</p> <p>VW 1600 (SIN PERFORAR) (83-94)</p>	<p>HO-269T \varnothingext. 48.00mm N.E. 1</p> <p>HYUNDAI VERNA (04-06)</p>	<p>HO-270 \varnothing54.35mm N.E. 1</p> <p>VW COMBI (PERFORADO) (74-98)</p>
<p>HO-270A \varnothing54.35mm N.E. 1</p> <p>VW COMBI (SIN PERFORAR) (74-98)</p>	<p>HO-341 \varnothing40.30mm N.E. 1</p> <p>VW 1800 (PERFORADO) (94-02)</p>	<p>HO-342 \varnothing40.30mm N.E. 1</p> <p>VW 1800 (SIN PERFORAR) (94-02)</p>
<p>HO-349 \varnothing40.30mm N.E. 1</p> <p>CHEVROLET CHEVY MONZA (96-02)</p>	<p>HO-375 \varnothing52.02mm N.E. 1</p> <p>VW JETTA (93-99)</p>	<p>HO-384 \varnothing51.16mm N.E. 1</p> <p>CHRYSLER CIRRUS, DODGE STRATUS (98-03)</p>
<p>HO-385 \varnothing47.60mm N.E. 1</p> <p>CHEVROLET CHEVY (03-04)</p>	<p>HO-389 \varnothing52.40mm N.E. 1</p> <p>NISSAN PLATINA (02-04)</p>	<p>HO-390 \varnothing52.30mm N.E. 1</p> <p>HYUNDAI ATOS (97-04)</p>
<p>HO-392 \varnothing51.80mm N.E. 1</p> <p>FIAT PALIO (02-03)</p>	<p>HO-393J \varnothing30.00mm N.E. 1</p> <p>FORD FIESTA IKON, KA (01-05) TORNILLO ROSCA IZQUIERDA</p>	<p>HO-461 \varnothing53.00mm N.E. 1</p> <p>CHEVROLET EXPRESS VAN 1500 (03-05)</p>

01800-1HUANTE

*HO-R= REPUESTO PARA CALIPER

*C.E.= CÓDIGO EQUIVALENTE *N.E. = NÚMERO DE EMPAQUE

HO-461A Ø.63.60mm
N.E. 1

CHEVROLET EXPRESS VAN 3500 (03-05)

HO-498 Ø.22.00mm
N.E. 1

PONTIAC MATIZ (05-07)

NUEVO

SEGUROS PARA CUBIERTA

HO-078 N.E. 5

P/RUEDA DE VW Ø int. 3/4"

HO-145

P/RUEDA DE COMBI Ø int. 7/8"

HO-081 Ø.int. 2 21/32"
N.E. 5

DINA 531 DODGE D-600

HO-081A Ø.int. 2 21/32"
N.E. 5

DINA 521 DODGE D-600 (PATON)

HO-082 Ø. int. 2"
N.E. 10

CHEVROLET CAMIONETA C-30 C-35 MICROBUS

HO-083 Ø.int. 2 5/32"
N.E. 5

CHEVROLET CAMIONETA C-20 AMERICANA

HO-084 Ø.int. 2 1/2"
N.E. 5

CHEVROLET C-50 C-60

HO-087 Ø. int. 3"
N.E. 5

DINA 631 SULTANA

HO-104 Ø.int. 3 1/4"
N.E. 5

DINA - 861

HO-124 Ø. int. 2 33/64"
N.E. 5

DODGE D-500

HO-125 N.E. 5

FORD F-350 Øint. 2 1/64" (2137)

HO-135 N.E. 10

FORD F-200 Øint. 1 13/16"

HO-134 Ø. int. 2 1/8"
N.E. 5

IHC INTERNATIONAL

01800-1HUANTE

HO-134A \varnothing . int. 2 1/8" N.E. 5

MERCEDES BENZ MICROBUS

HO-155 MEDIDA: Tuerca 1 1/16" N.E. 10

CORONA P/DODGE Y FORD PICK-UP (65-73)

HO-156 MEDIDA Tuerca 1 1/8" N.E. 10

CORONA P/DODGE FORD (82-94) AMERICAN RAMBLER (65-76)

HO-156A MEDIDA Tuerca 1 1/14" N.E. 10

CORONA P/CHRYSLER "K", FORD TOPAZ, NISSAN TSURU I (82-86), II (87-92) Y III (93-03)

HO-156B MEDIDA Tuerca 1 1/16" N.E. 10

CORONA P/NISSAN PICK-UP (91-07)

HO-167 \varnothing . int. 2" N.E. 10

DODGE D-300

HO-176 MEDIDA Tuerca 1 5/16" N.E. 10

CORONA P/ VW CARIBE (77-87)

HO-230 Chica N.E. 5
HO-231 Mediana
HO-232 Grande

ARANDELAS PARA ARAÑAS DE CHEVROLET

HO-280 MEDIDA: 18H x 1" N.E. 10

TUERCA PLANA P/ NISSAN PICK-UP (72-86), DATSUN SEDAN AUTO (72-86).

HO-281 MEDIDA Tuerca 16Hx1" N.E. 10

TUERCA PLANA PARA VW CARIBE, CORSAR, GOLF, JETTA, POINTER (89-91)

HO-281A MEDIDA 16H x 13/16" N.E. 10

TUERCA PLANA P/ FORD (82-94)

HO-281T \varnothing . int. 7/8" N.E. 5

TUERCA ESPIGA FORD MUSTANG (94-05), LINCOLN TOWN CAR (98-05), MERCURY GRAND MARQUIS (92-04)

HO-282 MEDIDA 16H x 3/4" N.E. 10

TUERCA PLANA P/ CHRYSLER SHADOW, SPIRIT, DODGE D-100, FORD E-150/E-250, E-350, LOBO, TRITON (82-94)

HO-282A \varnothing . int. 22mm N.E. 5

TUERCA PLANA PARA CHRYSLER "K" (82-94), FORD FOCUS (02-03), NISSAN SENTRA (90-94), TSURU II (87-92) Y III (93-04)

HO-283 MEDIDA 16H X 7/8" N.E. 5

TUERCA PLANA P/DODGE D-300 (73-90)

01800-1HUANTE

HO-284 Ø. int. 22mm
N.E. 5

**CASTILLO P/VW
SEDAN (74-04)**

HO-285 Ø. int. 28mm
N.E. 5

**CASTILLO P/VW
COMBI (73-90)**

HO-286 MEDIDA:
20H x 3/4"
N.E. 10

**CASTILLO PARA
CHEVROLET C-10, C-15,
S-10, S-15, SUBURBAN
(71-93), BLAZER (82-93),
IMPALA (71-79),
MALIBU (71-83).**

HO-287 MEDIDA:
16H x 3/4"
N.E. 10

**TUERCA CASTILLO
CHRYSLER "K"
(82-94), FORD F-100
F-150 LOBO
(96-03)**

HO-288 MEDIDA:
14H x 7/8"
N.E. 10

**CASTILLO PARA
FORD F-350
(71-03)**

HO-289 MEDIDA:
20H x 27/32"
N.E. 10

**CASTILLO PARA
CHEVROLET C-30
(71-96)**

HO-289A MEDIDA:
Ø int. 18 mm
N.E. 5

**TUERCA ESPIGA
P/CHEVROLET
CAVALIER,
OLDSMOBILE
CUTLASS (92-05)**

HO-289T MEDIDA:
Ø int. 20.45 mm
N.E. 5

**TUERCA RUEDA
TRASERA P/
HYUNDAI VERNA
(04-06), NISSAN
SENTRA (01-05),
MAXIMA (93-05)**

HO-290 MEDIDA:
Ø int. 20 mm
N.E. 5

**TUERCA ESPIGA P/
FORD TOPAZ (82-94),
VW CARIBE (82-86),
JETTA, GOLF (87-96),
FOCUS RT (01-03)**

HO-291 MEDIDA:
Ø int. 22 mm
N.E. 5

**TUERCA ESPIGA
PLANA P/NISSAN
TSURU I (84-87)**

HO-292 MEDIDA:
Ø int. 22 mm
N.E. 5

**TUERCA ESPIGA
TRASERA TIPO
CAMPANA PARA
NISSAN TSURU II
(87-92) Y III (93-03)**

HO-292T MEDIDA:
Ø int. 22.45 mm
N.E. 5

**TUERCA RUEDA
NISSAN SENTRA QR25
(01-05), XTRAIL (01-05)
(DELANTERA Y
TRASERA), MURANO
(03-05), ALTIMA (01-05),
MAXIMA (95-05)**

HO-293 Ø.int. 17.20mm
N.E. 5

**TUERCA PIÑÓN
CHEVROLET C-15 (65-95),
DODGE D-150 (65-95),
FORD F-150 (65-95).**

HO-293E

**TUERCA PIÑÓN
ECONÓMICA CHEVROLET
C-15 (65-95), DODGE D-150
(65-95), FORD F-150 (65-95).**

HO-294 Ø.int. 20.40 mm
N.E. 5

**TCA. PIÑÓN CHEVROLET
C-30 DODGE D-300/D-350,
FORD F-350 (65-01)**

HO-294E

**TCA. PIÑÓN ECONÓMICA
CHEVROLET C-30 DODGE
D-300/D-350 - FORD F-350
(65-01)**

HO-295 Ø. 16H x 7/8"
N.E. 5

**TUERCA PIÑÓN
CHEVROLET C-30
DODGE D-300/D-350
FORD F-350 (65-01)**

HO-299 N.E. 20

SEGURO PARA TUERCA FORD F-350

autopartes autopartes

HO-299A Ø. int. 1 31/32" N.E. 5

TUERCA CON INSERTO DE NYLON PARA FORD-350 (65-95)

autopartes autopartes

HO-319 N.E. 1

SEGURO INTERIOR PARA MAZA DE CHEVROLET MICRO (90-96)

autopartes autopartes

HO-320 N.E. 1

SEGURO INTERIOR CON OREJAS PARA MAZA DE CHEVROLET MICRO (90-96)

autopartes

HO-321 Ø. int. 3 5/16" N.E. 5

TRACTO CAMION FAMSA

autopartes autopartes

HO-356 N.E. 5

SEGURO RUEDA DELANTERA CHEVROLET LUMINA OLDSMOBILE CUTLASS (87-91)

autopartes

HO-378 MEDIDA: Tuerca 1 1/4" N.E. 10

CORONA PARA RUEDA DODGE CARAVAN (84-95)

autopartes

HO-388 Ø. int. 2 1/32" N.E. 10

SEGURO RUEDA VW 1800 (94-03)

autopartes

HO-393 N.E. 1

SEGURO INTERIOR CON OREJAS PARA MAZA DE CHEVROLET HEAVY DUTY (99-01)

autopartes

HO-394 Ø. int. 7/8" N.E. 5

TUERCA DELANTERA CHEVROLET MALIBU (00-05) JEEP LIBERTY (02-05)

autopartes

HO-395 Ø. int. 3/4" N.E. 5

TUERCA DELANTERA FORD FOCUS (00-04)

autopartes

HO-396 Ø. int. 13/16" N.E. 5

TUERCA DELANTERA FORD CONTOUR, MERCURY MYSTIQUE (95-05)

autopartes

HO-397 Ø. int. 13/16" N.E. 5

TUERCA DELANTERA FORD FIESTA, IKON (01-05)

autopartes

HO-397A Ø. int. 1" N.E. 2

TUERCA MANGO NISSAN URVAN (02-06)

autopartes

HO-397B Ø. int. 2 1/32" N.E. 5

SEGURO NISSAN URVAN (99-05)

autopartes

01800-1HUANTE

*HO-R= REPUESTO PARA CALIPER
*C.E.= CÓDIGO EQUIVALENTE *N.E. = NÚMERO DE EMPAQUE

HO-499 \varnothing .Int. 1 11/16"
N.E. 5

SEGURO MAZDA
MAZDA B-1800,
B-2000, B-2200
(89-96)

HO-819 \varnothing .22.00 mm.
N.E. 1

TUERCA PARA MANGO CON RETEN DODGE RAM CHARGER, D-150 (88-00)

HO-912 \varnothing .int. 39.73 mm
N.E. 4

TUERCA PARA CUBIERTA DE DOBLE TRACCIÓN SIN PERNO FORD, CHRYSLER, GMC (89-94)

HO-913 \varnothing .int. 39.65 mm
N.E. 4

TUERCA PARA CUBIERTA DE DOBLE TRACCIÓN CON PERNO FORD, CHRYSLER, GMC. (89-94)

HO-914 \varnothing .int. 41.56 mm.
N.E. 10

ARANDELA PARA DOBLE TRACCIÓN FORD, CHRYSLER, GMC (89-94)

HO-922 \varnothing .int. 21 mm.
N.E. 5

TUERCA DELANTERA HYUNDAI ATOS (97-04), HYUNDAI VERNA (97-05)

HO-012H **MEDIDA:**
 \varnothing int. 21/32"
 \varnothing ext. 1 3/8"
N.E. 5

DATSUN AUTO

HO-012HA **MEDIDA:**
 \varnothing int. 1 3/32"
 \varnothing ext. 1 25/32"
N.E. 5

NISSAN TSURU II Y III TRASERA

HO-013H **MEDIDA:**
 \varnothing int. 27/32"
 \varnothing ext. 1 21/32"
N.E. 5

V.A.M. RAMBLER AUTO

HO-027H **MEDIDA:**
 \varnothing int. 3/4"
 \varnothing ext. 1 21/32"
N.E. 5

CHEVROLET C-10

HO-028H **MEDIDA:**
 \varnothing int. 7/8"
 \varnothing ext. 2 1/4"
N.E. 5

CHEVROLET C-30

HO-029H **MEDIDA:**
 \varnothing int. 1 5/32"
 \varnothing ext. 2 39/64"
N.E. 5

DINA 5121

HO-047 MEDIDA:
Ø int. 25/32"
Ø ext. 1 25/32"

N.E. 5

CHEVROLET
AUTO

HO-047T N.E.10

MEDIDA:
Ø int. 23.00mm Ø ext. 38.50mm

DODGE STRATUS
CHRYSLER VOYAGER (96-05)
ALINEACION TSURU III

HO-048 MEDIDA:
Ø int. 7/8"
Ø ext. 1 33/32"

CHEVROLET
CAMIONETA

N.E. 5

HO-048A N.E. 5

FORD
F-150 F-350

MEDIDA:
Ø int. 3/4"
Ø ext. 1 21/32"

HO-048B MEDIDA:
Ø int. 3/4"
Ø ext. 1 21/32"

N.E. 5

FORD
ECONOLINE
VAN E-150
F-200

HO-079 MEDIDA:
Ø int. 21/32"
Ø ext. 1 11/32"

N.E. 5

VW SEDAN

HO-079A MEDIDA:
Ø int. 20 mm
Ø ext. 1 1/2"

N.E. 5

VW COMBI

HO-080 MEDIDA:
Ø int. 1 5/32"
Ø ext. 2 5/8"

N.E. 5

CHEVROLET
C-50 C-60
DINA

HO-095 MEDIDA:
Ø int. 25/32"
Ø ext. 1 13/32"

N.E. 5

DODGE
AUTOS

HO-146 MEDIDA:
Ø int. 26mm
Ø ext. 2 5/8"

N.E. 5

DINA DODGE

HO-146A MEDIDA:
Ø int. 1"
Ø ext. 2 1/8"

N.E. 5

DODGE
D-600

HO-147 MEDIDA:
Ø int. 15/16"
Ø ext. 1 25/32"

N.E. 5

FORD AUTO

HO-148 MEDIDA:
Ø int. 1 1/32"
Ø ext. 1 31/32"

N.E. 5

FORD
CAMIONETA

HO-181 MEDIDA:
Ø int. 1 1/2"
Ø ext. 3 3/64"

N.E. 5

SEGURO P/
KENWORTH
DINA-631

HO-355 MEDIDA:
Ø int. 21/32"
Ø ext. 1 3/8"

N.E. 5

CHEVROLET
CHEVY
MONZA

HO-377 MEDIDA:
Ø int. 18.50mm
Ø ext. 43.00mm

N.E. 5

NISSAN
PICK-UP

01800-1HUANTE

HO-517

CUÑA PARA FLECHA 5/16"

HO-518

CUÑA PARA FLECHA 3/8"

HO-519

CUÑA PARA FLECHA 1/4"

HO-728

CUÑA PARA FLECHA 3/16"

N.E. 5

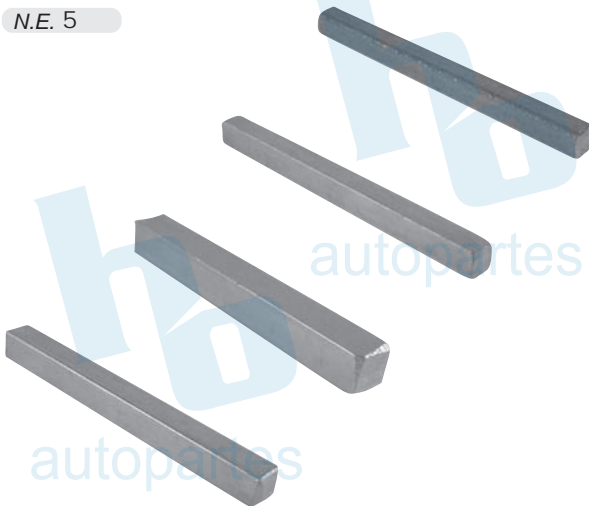

HO-624

JUNTAS PARA FLECHA DE ASBESTO PARA DODGE / FORD.

HO-624A

JUNTAS PARA FLECHA DE ALUMINIO PARA DODGE / FORD.

HO-625

JUNTAS PARA FLECHA DE ASBESTO PARA CHEVROLET C-30.

HO-625A

JUNTAS PARA FLECHA DE ALUMINIO PARA CHEVROLET C-30.

N.E. 10



ABRAZADERAS Y SEGUROS PARA CRUCETA

HO-006H

N.E. 10

ABRAZADERA PARA CRUCETA # 45311 DE 1/4"



HO-007H

N.E. 10

ABRAZADERA PARA CRUCETA # 5-200X 521 DE 5/16"



HO-008H

N.E. 10

ABRAZADERA PARA CRUCETA # 5-160X 560 DE 3/8"



HO-009H

N.E. 1

ABRAZADERA PARA CRUCETA # 588 DE 7/16"



ABRAZADERAS Y SEGUROS PARA CRUCETA



HO-126

N.E. 10

ABRAZADERA
PARA CRUCETA
22917 DODGE
CAMIONETA



HO-126A

N.E. 10

ABRAZADERA
PARA CRUCETA
33017 DODGE
CAMION



HO-126B

N.E. 10

ABRAZADERA PARA
CRUCETA
30814 CHEVROLET,
DODGE,
FORD LOBO



HO-173

N.E. 10

SEGURO DE
CRUCETA
PARA DINA



HO-376

N.E. 10

JUEGO DE
ABRAZADERA
P/CRUCETA
SPICER
5-160X

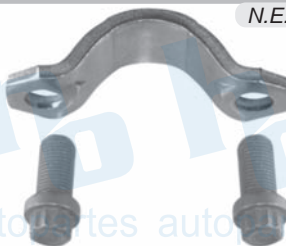

01800-1HUANTE

PARTES PARA BOOSTER



HO-861

N.E. 1

VÁLVULA DE
RETENCIÓN
PARA CHRYSLER
(81-91)



HO-862

N.E. 1

FILTRO BOOSTER
PARA CHRYSLER/
GMC (78-94)



HO-864

N.E. 5

VÁLVULA DE
RETENCIÓN TIPO
UNIVERSAL



HO-864A

N.E. 5

VÁLVULA DOBLE
DE RETENCIÓN
UNIVERSAL



*HO-R= REPUESTO PARA CALIPER

*C.E.= CÓDIGO EQUIVALENTE *N.E. = NÚMERO DE EMPAQUE

HO-871 N.E. 5

GOMA DE VÁLVULA DE RETENCIÓN GRANDE



HO-872 N.E. 5

GOMA DE VÁLVULA DE RETENCIÓN CHICA



CUENCAS Y PARTES PARA CLUTCH

01800-1HUANTE

HO-014H N.E. 10

DODGE CAMION D-600 VALIANT



HO-014HA N.E. 10

DODGE CAMIONETA D-100, D-150, D-300



HO-014HB N.E. 10

FORD AUTO MODELO VIEJO



HO-014HC N.E. 10

FORD PICK UP CAMIONETA



HO-023H N.E. 10

FORD FALCON



HO-024H N.E. 10

FORD CAMIONETA F-150, F-200, F-350



HO-031 N.E. 100

HO-031A

MEDIDA: Ø int. 3/8" Ø ext. 5/16"

RONDANAS PARA CLUTCH



HO-043H N.E. 10

AMERICAN V.A.M. RAMBLER



HO-044H N.E. 10

AMERICAN V.A.M. RAMBLER TIPO VASO



HO-045H N.E. 10

CHEVROLET AUTO Y CAMIONETA

HO-132 N.E. 10

SEGURO PARA TEMPLADOR DE DODGE

HO-164 N.E. 10

SEGURO CHICOTE DE CLUTCH PARA VW COMBI

AJUSTES PARA CLUTCH

HO-105 N.E. 1

DODGE AUTO VALIANT (65-77)

HO-107 N.E. 1

P/FORD AUTO Y CAMIONETA PICK UP (65-79)

HO-106 N.E. 1

DODGE CAMIONETA Y CAMIÓN D-500, D-600 (76-82)

HO-108 N.E. 1

FORD CAMIÓN F-600 (67-79)

HO-189 N.E. 1

CHEVROLET CAMIONETA (72-78)

HO-190 N.E. 1

P/CHEVROLET CAMIÓN (71-78)

HO-189A N.E. 1

CHEVROLET MICROBUS (90-96)

01800-1HUANTE

AJUSTES PARA CLUTCH

HO-191

N.E. 1



DINA 3000, 3200, 531, 631, 661, SUPERIOR (65-73)

HO-191B

Ø.int. 7/16"
N.E. 1

DINA REFORZADO
CON HORQUILLA
(65-73)



HO-192

N.E. 1



CHEVROLET CHEVY NOVA, MALIBU (70-79)

VARILLAS PARA CLUTCH

HO-112

VARILLA EN C PARA
FORD (65-79) L. 17"

N.E. 1

HO-113

VARILLA EN C PARA
FORD (65-79) L. 19"



HO-112A

VARILLA EN Z PARA FORD
(65-81) L. 17"

N.E. 1

HO-113A

VARILLA EN Z PARA CHEVROLET
MICRO (90-96) L. 20"



HO-114

VARILLA EN C PARA
FORD L. 21"

N.E. 1

HO-114A

VARILLA EN C PARA
FORD L. 25"



HO-114B

VARILLA CURVA PARA
CHEVROLET MICRO (90-96)

N.E. 1



01800-1HUANTE

HORQUILLAS PARA CLUTCH

HO-193 3/8

N.E. 1

HO-193 7/16

HORQUILLA PARA
CLUTCH DE DINA
(65-73)



HO-193A DE 1/2"

N.E. 1

HO-193B DE 5/8"

HORQUILLA PARA
CLUTCH
ROTOCHAMBER

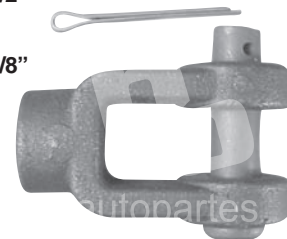

HO-271

N.E. 1

REPUESTO PARA HORQUILLA DE CLUTCH (HC-GM) (HC-GM2) (HC-AMC13) CHEVROLET MICROBUS (90-96)



HO-348

N.E. 1

REPUESTO SEGURO HORQUILLA (HC-Z5TA) (HC-72TY) FORD (69-79)



HO-467

CHICO
Ø 18.04 mm / h. 19.70 mm

HO-468

GRANDE
Ø 25.30 mm / h. 20.93 mm

N.E.10

BUJES PARA PEDAL DE CLUTCH CHRYSLER DODGE



HO-473

N.E. 1

JUEGO DE BUJES PARA PEDAL DE FRENO FORD F-100, F-150, F-250, F350 (98-03)



HO-486

N.E. 1

SOPORTE DE CLUTCH FORD F-350, F-450, F-550, TRITON (99-02).

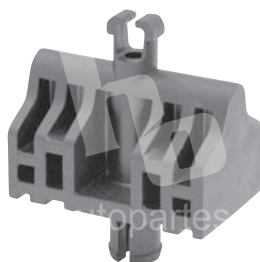

HO-685

N.E. 1

HORQUILLA PARA CLUTCH HYUNDAI ATOS (01-07)

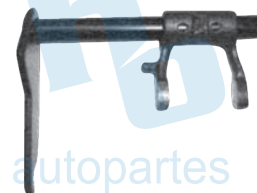

NUEVO

NUEVO HO-686

N.E. 1

HORQUILLA PARA CLUTCH NISSAN TSURU (98-07)



HO-689

N.E. 2

HORQUILLA PARA CLUTCH CHEVROLET CHEVY (99-07)

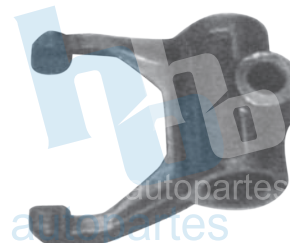

NUEVO

NUEVO HO-890

N.E. 5

JUEGO DE BUJES PARA PEDAL DE FRENO Y CLUTCH NISSAN PLATINA, RENAULT CLIO.

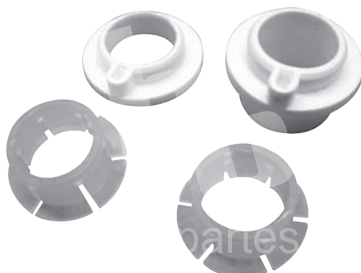

HO-891

N.E. 5

JUEGO DE BUJES PARA PEDAL DE FRENO Y CLUTCH HYUNDAI ATOS



NUEVO

01800-1HUANTE

HO-668 N.E. 1

COLUMPIO PARA VARILLAS DE CLUTCH DE CHEVROLET MICROBUS (90-96)

HO-675 N.E. 1

BALANCIN DE CLUTCH PARA CHEVROLET MICROBUS (90-96)

HO-705 N.E. 10
(PLÁSTICO)

HO-705N
(NYLON)

BUJE PARA BOMBA DE CLUTCH DE FORD PICK-UP (92-98)

HO-755 N.E. 10
CHICO
Ø 15.43 mm
h. 12.31 mm

HO-755A N.E. 10
GRANDE
Ø 19.74 mm
h. 20.07 mm

HO-756 N.E. 10
MEDIANO
Ø 15.29 mm
h. 17.56 mm

BUJES PARA PEDAL CLUTCH - FRENO

HO-785 N.E. 10

Ø int. 14.60 mm
h. 19.78 mm

BUJES PARA PEDAL FRENO NISSAN TSURU

HO-785A N.E. 10

Ø int. 14.47 mm
h. 19.50 mm

BUJES PARA PEDAL DE FRENO DODGE

HO-814 N.E. 1

KIT DE BUJES PARA PEDAL DE FRENO Y CLUTCH CHEVROLET 1500-3600

HO-852 N.E. 1

SOLERA P/VARILLA DE CLUTCH CHEVROLET MICROBUS (90-96)

RS-100 N.E. 10

RESORTE PARA CLUTCH UNIVERSAL LARGO 36.50 cm

RS-312 N.E. 10

RESORTE PARA CLUTCH UNIVERSAL LARGO 38.00 cm

HO-017H N.E. 10

VW 1500



HO-018H

DINA 531

SEGUROS PORTACOLLARÍN

HO-018HA N.E. 10



JUEGO DE SEGUROS PARA DODGE

HO-018HB N.E. 10



JUEGO DE SEGUROS PARA COLLARIN DE NISSAN TSURU

HO-018HC N.E. 5



SEGURO PORTACOLLARÍN DATSUN

HO-345 N.E. 5



SEGURO COLLARIN BUICK CENTURY (87-94), CHEVROLET CAVALIER (90-92), OLDSMOBILE CUTLASS (87-97).

HO-386 N.E. 5



SEGURO COLLARIN 614108 CHEVROLET 4 Y 6 CILINDROS, PONTIAC GRAND AM U.S.A.

HO-387 N.E. 1



JUEGO DE SEGUROS COLLARIN V.W. 1600

HO-399 N.E. 5



SEGURO COLLARIN HYUNDAI ATOS (02-05)

01800-1HUANTE

VARILLAS EMPUJE DE CLUTCH

HO-491 N.E. 5



VW, GOLF, JETTA, CORTA 31.00 cm

HO-492 N.E. 5



VW, GOLF, JETTA, LARGA 34.00 cm

BUJES DE BRONCE PARA FLECHA PILOTO

HO-218 N.E. 10

MEDIDAS
 Ø Int. 15 mm
 Ø Ext. 28 mm
 h. 19 mm

CHEVROLET



HO-219 N.E. 10

MEDIDAS
 Ø Int. 16 mm
 Ø Ext. 21 mm
 h. 18 mm

DATSUN



HO-220 N.E. 10

MEDIDAS
 Ø Int. 19 mm
 Ø Ext. 24 mm
 h. 22 mm

DODGE



HO-221 N.E. 10

MEDIDAS
 Ø Int. 17 mm
 Ø Ext. 35 mm
 h. 13 mm

FORD 302



HO-222 N.E. 5

MEDIDAS
 Ø Int. 17 mm
 Ø Ext. 47 mm
 h. 13 mm

**FORD AMERICANO
 MAQ. 390**



HO-223 N.E. 10

MEDIDAS
 Ø Int. 16 mm
 Ø Ext. 35 mm
 h. 13 mm

FORD 351



BUJES Y BALEROS PARA FLECHA PILOTO

HO-224 N.E. 5

MEDIDAS
 Ø Int. 17 mm
 Ø Ext. 40 mm
 h. 13 mm

FORD 240



HO-225 N.E. 5

MEDIDAS
 Ø Int. 25 mm
 Ø Ext. 40 mm
 h. 13 mm

FORD CAMIÓN



HO-226 N.E. 5

MEDIDAS
 Ø Int. 19 mm
 Ø Ext. 25 mm
 h. 19 mm

**V.A.M.
 RAMBLER**



HO-227 N.E. 5

MEDIDAS
 Ø Int. 12 mm
 Ø Ext. 16 mm
 h. 20 mm

RENAULT



HO-228 N.E. 5

MEDIDAS
 Ø Int. 19 mm
 Ø Ext. 27 mm
 h. 19 mm

DINA



HO-229 N.E. 5

MEDIDAS
 Ø Int. 17 mm
 Ø Ext. 27 mm
 h. 16 mm

**AMERICAN V.A.M.
 RAMBLER**



HO-358 N.E. 10

MEDIDAS
 Ø Int. 15 mm
 Ø Ext. 21 mm
 h. 19 mm

**CHEVROLET
 BLAZER, S-10**



HO-750 N.E. 5

**FORD
 (MAQUINA 302)**



HO-750A N.E. 5

**DODGE
 (MAQUINA 360)**



01800-1HUANTE

HO-750B N.E. 10

CHEVROLET
6 Y 8 CILINDROS



HO-750C N.E. 10

AUDI A3, A4, CHEVROLET
ASTRA, CORSA LUV,
VECTRA, ZAFIRA,
FORD CONTOUR,
ESCORT, MONDEO
RANGER,
MERCURYMYSTIQUE



HO-750D N.E. 10

VW BEETLE 1.8 Y
2.0 GOLF, JETTA,
POINTER.



HO-750E N.E. 5

DODGE DAKOTA
(95-01)



HO-750F N.E. 5

FORD F-350,
SUPER DUTY,
F-65A7120AA



HO-750G N.E. 5

FORD F-350
SUPER DUTY
F3TA-7120AA
E3TZ-7600B



PARTES DE CLUTCH PARA VOLKSWAGEN

HO-077H N.E. 1

PERNO DE PEDAL
VW 1500-1600



HO-077HA N.E. 10

PERNO
EJE PEDAL
CLUTCH
1500-1600



HO-504 N.E. 10

MARIPOSA P/
CHICOTE
DE CLUTCH
VW-COMBI



HO-593 N.E. 1

HORQUILLA PARA
VW SEDAN 1500
(65-73)

HO-594

HORQUILLA PARA VW
SEDAN 1600 (74-03)

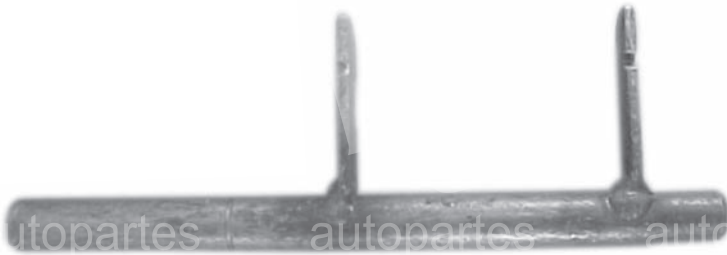

HO-594A N.E. 1

HORQUILLA PARA
CLUTCH VW
EUROVAN (00-05)



01800-1HUANTE

HO-629

DELGADA

N.E. 1

HO-629G

GRUESA

HORQUILLA PARA VW COMBI (73-02)



HO-660

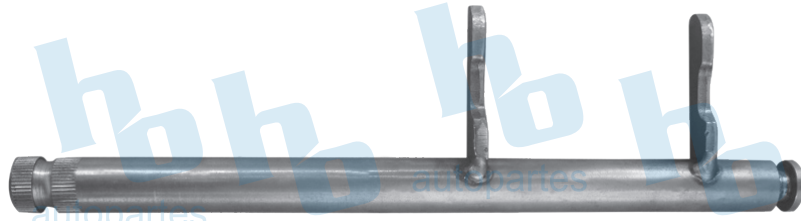

HORQUILLA PARA CLUTCH VW POINTER (02-05)

HO-672

N.E. 1

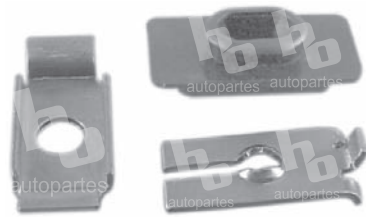

JUEGO DE SEGUROS PARA CHICOTE DE CHRYSLER "K", VW CARIBE (82-87)

HO-672A

N.E. 1

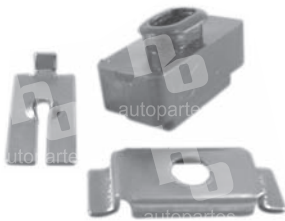

JUEGO DE SEGUROS PARA CHICOTE DE VW GOLF (92-97)

HO-692

N.E. 10



BUJE PERNO PEDAL DE CLUTCH VW SEDAN 1500 (65-73), 1600 (74-03)

HO-786

N.E. 5

DELGADO

HO-786B

GRUESO



BUJE DE PLÁSTICO PARA HORQUILLA VW SEDAN 1500 (65-73), 1600 (74-03)

HO-786A

N.E. 5



BUJE DE BRONCE PARA HORQUILLA VW SEDAN 1500 (65-73), 1600 (74-03)

HO-788

N.E. 10



BUJE MAROMA CLUTCH VW JETTA (92-97)

HO-792

N.E. 1



CANDELERO DE CLUTCH PARA VW SEDAN

HO-816

N.E. 1

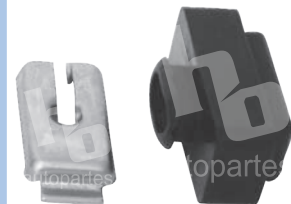

KIT DE GOMA PARA CHICOTE DE CLUTCH VW GOLF, JETTA A3

01800-1HUANTE